



GE - Cotonette cremeton



OE - Cotonette orange



R - Cotonette rot



GR - Cotonette apfelgrün



BR - Cotonette Schokolade



AG - Cotonette graphitgrau



S - Cotonette schwarz



SL - Cotonette schlammton

Crayon 50, 3x E27 8W

Metallteile verchromt, Kunststoffdiffuser satin

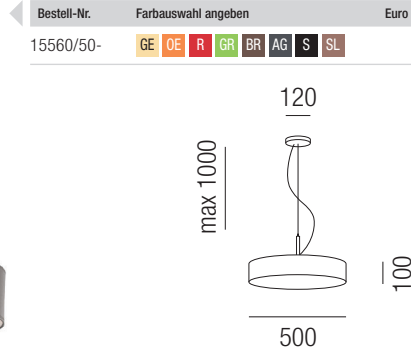

Crayon 50 dezentral, 3x E27 8W

Metallteile verchromt, dezentrale Aufhängung, Kunststoffdiffuser satin



Crayon 60, 3x E27 8W

Metallteile verchromt, Kunststoffdiffuser satin

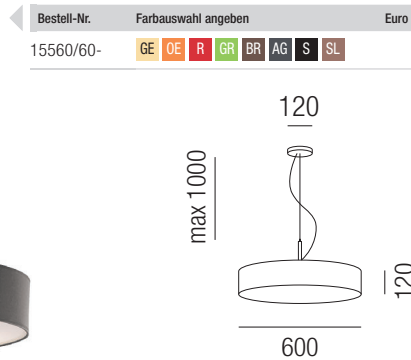

Crayon 80, 3x E27 8W

Metallteile verchromt, Kunststoffdiffuser satin



Crayon 2x50, 6x E27 8W

Metallteile verchromt, dezentrale Aufhängung, Kunststoffdiffuser satin

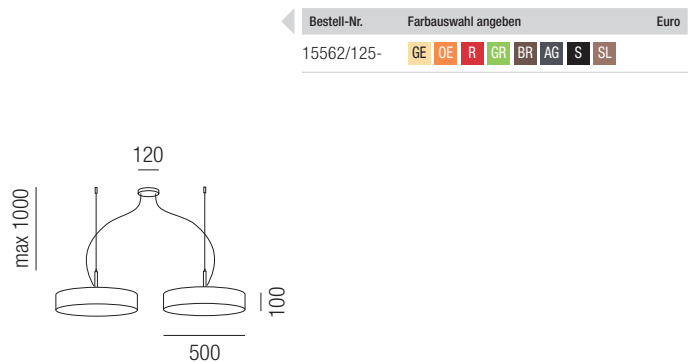

Crayon 50, 3x E27 8W

Direktmontage, Kunststoffdiffuser satin



| Bestell-Nr. | Farbauswahl angeben | Euro |
|-------------|-----------------------|------|
| 15571/50- | GE OE R GR BR AG S SL | |

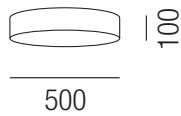

Crayon 50, 3x E27 8W

Metallteile verchromt, abgesetzte Montage, Kunststoffdiffuser satin



| Bestell-Nr. | Farbauswahl angeben | Euro |
|-------------|-----------------------|------|
| 15570/50- | GE OE R GR BR AG S SL | |

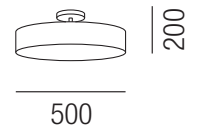

Crayon 60, 3x E27 8W

Direktmontage, Kunststoffdiffuser satin



| Bestell-Nr. | Farbauswahl angeben | Euro |
|-------------|-----------------------|------|
| 15571/60- | GE OE R GR BR AG S SL | |

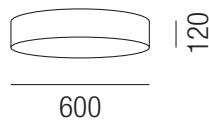

Crayon 60, 3x E27 8W

Metallteile verchromt, abgesetzte Montage, Kunststoffdiffuser satin



| Bestell-Nr. | Farbauswahl angeben | Euro |
|-------------|-----------------------|------|
| 15570/60- | GE OE R GR BR AG S SL | |

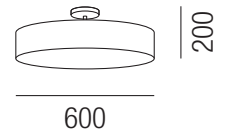

Crayon 80, 3x E27 8W

Direktmontage, Kunststoffdiffuser satin



| Bestell-Nr. | Farbauswahl angeben | Euro |
|-------------|-----------------------|------|
| 15571/80- | GE OE R GR BR AG S SL | |

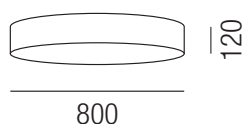



Crayon 80, 3x E27 8W

Metallteile verchromt, abgesetzte Montage, Kunststoffdiffuser satin

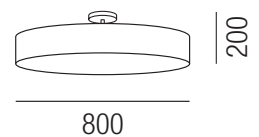

| Bestell-Nr. | Farbauswahl angeben | Euro |
|-------------|-----------------------|------|
| 15570/80- | GE OE R GR BR AG S SL | |



Crayon, 1x E27 8W 

Metallteile verchromt, Bodenplatte Pinienholz dunkel, Kunststoffdiffuser satin

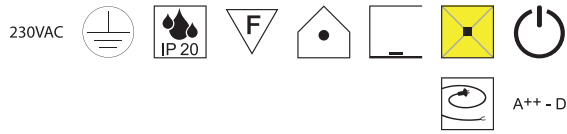

| Bestell-Nr. | Farbauswahl angeben | Euro |
|-------------|--|------|
| 15555/150- | <input type="checkbox"/> GE <input type="checkbox"/> OE <input checked="" type="checkbox"/> R <input type="checkbox"/> GR <input type="checkbox"/> BR <input type="checkbox"/> AG <input type="checkbox"/> S <input type="checkbox"/> SL | |



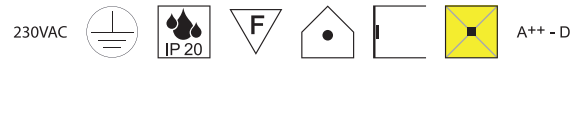

Crayon, 2x E27 8W 

Wandblende

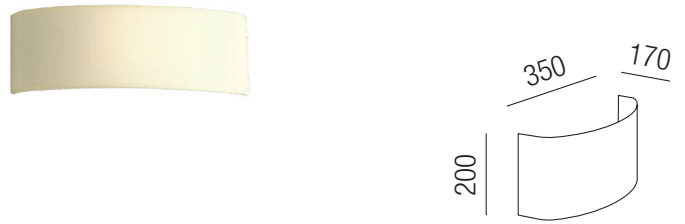

| Bestell-Nr. | Farbauswahl angeben | Euro |
|-------------|--|------|
| 15433/35- | <input type="checkbox"/> GE <input type="checkbox"/> OE <input checked="" type="checkbox"/> R <input type="checkbox"/> GR <input type="checkbox"/> BR <input type="checkbox"/> AG <input type="checkbox"/> S <input type="checkbox"/> SL | |



Crayon, 1x E27 8W 

Metallteile verchromt, Bodenplatte Pinienholz dunkel, Kunststoffdiffuser satin

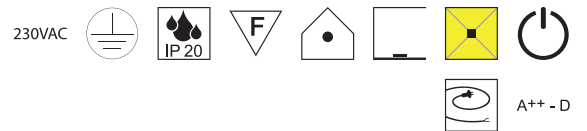

| Bestell-Nr. | Farbauswahl angeben | Euro |
|-------------|--|------|
| 15590/35- | <input type="checkbox"/> GE <input type="checkbox"/> OE <input checked="" type="checkbox"/> R <input type="checkbox"/> GR <input type="checkbox"/> BR <input type="checkbox"/> AG <input type="checkbox"/> S <input type="checkbox"/> SL | |



Crayon, 1x E27 8W 

Metallteile verchromt, Bodenplatte Pinienholz dunkel, Kunststoffdiffuser satin

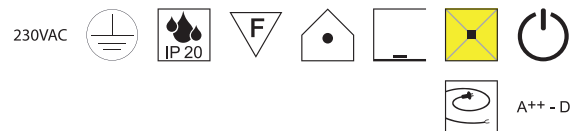

| Bestell-Nr. | Farbauswahl angeben | Euro |
|-------------|--|------|
| 15590/45- | <input type="checkbox"/> GE <input type="checkbox"/> OE <input checked="" type="checkbox"/> R <input type="checkbox"/> GR <input type="checkbox"/> BR <input type="checkbox"/> AG <input type="checkbox"/> S <input type="checkbox"/> SL | |

